

FIXING HARDWARE: BTB FIXING KIT INCLUDED  
STANDARD THICKNESS: FROM 8 mm TO 20 mm  
OTHER THICKNESS KIT AVAILABLE. PLEASE SPECIFY

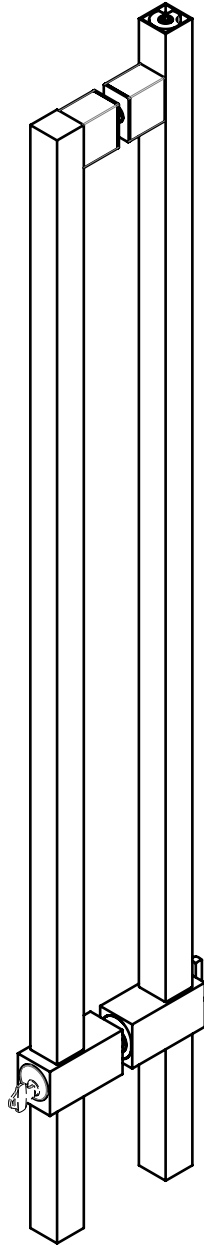

DETAIL A

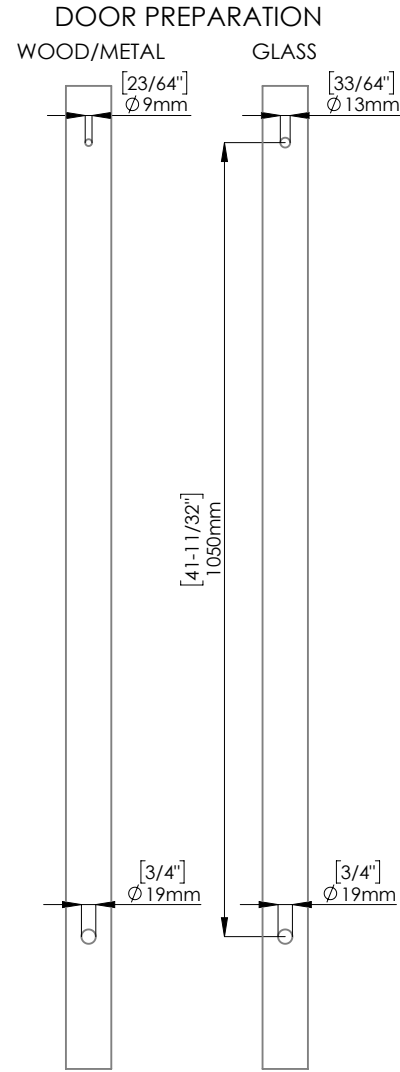
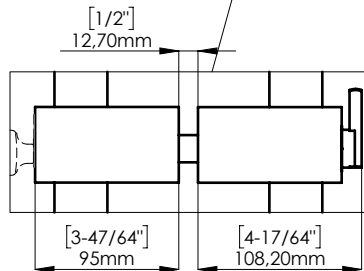
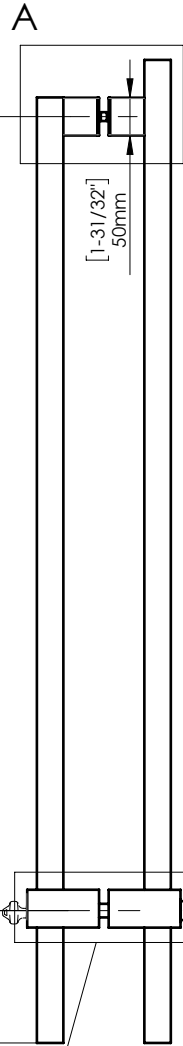
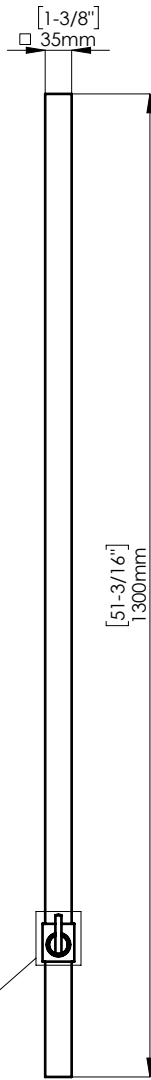
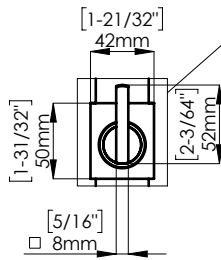
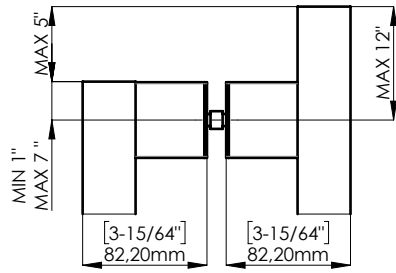

INCLUDED ACCESSORIES

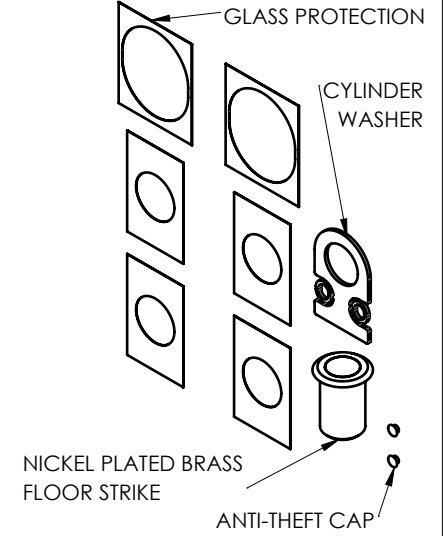

CYLINDER (NOT INCLUDED)  
\*AVAILABLE ON REQUEST

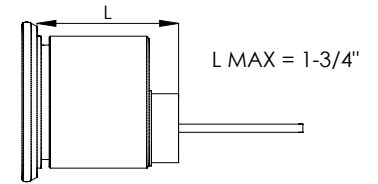

PBA UNIVERSAL BACKPLATE  
INCLUDED WITH LOCKING PULL

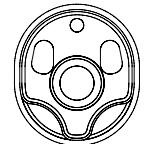

ALLOWS TO ACCOMODATE  
ANY RIM CYLINDER BRAND OR  
FORMAT

AVAILABLE FORMATS:

